

Technik-Plus

For following models:

Öko-Air

Serial number: _____

Translation from original instruction



TECHNIK-PLUS Sämaschinen e.U.
Industrieparkstraße 6-8, A-8480 Mureck
Tel: 0043 (0)3472 21123
www.technik-plus.eu
technik-plus@technik-plus.eu



Status: 12/2013

Content

- 1. ICONS.....3**
- 2. CE-CONFORMITY3**
- 3. FIRST STEPS.....4**
- 4. RELAYING.....4**
- 5. SAFETY INSTRUCTION4**
 - 5.1. DANGER AREA..... 4
 - 5.2. IN GENERAL 5
 - 5.3. CONTROL AND ELECTRICAL CONNECTION 5
 - 5.4. FITTING AND CONSOLE 6
- 6. OPERATION.....6**
- 7. WARRANTY.....6**
- 8. PRODUCT LIABILITY.....7**
- 9. DESCRIPTION7**
- 10. MOUNTING7**
 - 10.1. MOUNTING HOPPER WITH MACHINE FRAME 7
 - 10.2. NOTES FOR HOSE MOUNTING 9
 - 10.3. HINTS FOR HOSE MOUNTING 10
 - 10.4. MOUNTING OF THE ON/OFF SENSOR 11
- 11. CONTROL UNIT.....11**
 - 11.1. CONNECTION 11
 - 11.2. DESCRIPTION 11
- 12. OPERATION.....12**
 - 12.1. PREPERATION 12
 - 12.2. CALIBRATION 13
- 13. ADDITIONS.....14**
 - 13.1. CHANGING OF SEED ROLL 14
 - 13.2. CONNECTIONS 15
 - 13.3. SERVICE 15
- ATTACHEMENT 1: DECLARATION OF CONFORMITY.....16**

1. Description of the Icons on your Öko-Air:

Icons point out possible danger areas. They serve the safety of all persons who work with the seeder or have to do with it in any way. Icons must be displaced and can be reordered with the quoted order number.

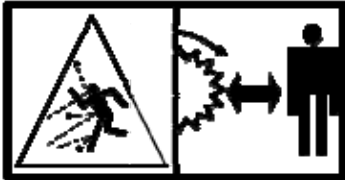

During operation of the machine do not enter the danger area. People and animals can be injured or objects can be damaged.

Order-No.: 10559908

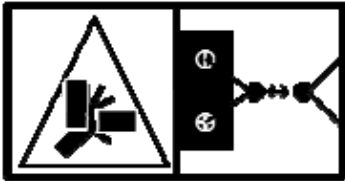

Before working on the machine be sure that the power supply is disconnected.

Order-No.: 10559909

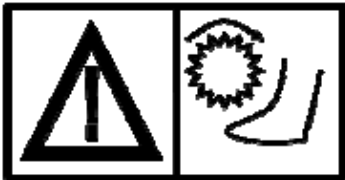

Attention to rotating parts! Everywhere you can see this note there are rotating parts behind the cover.

Order-No.: 10559907

The Icons are on the frame of the machine.

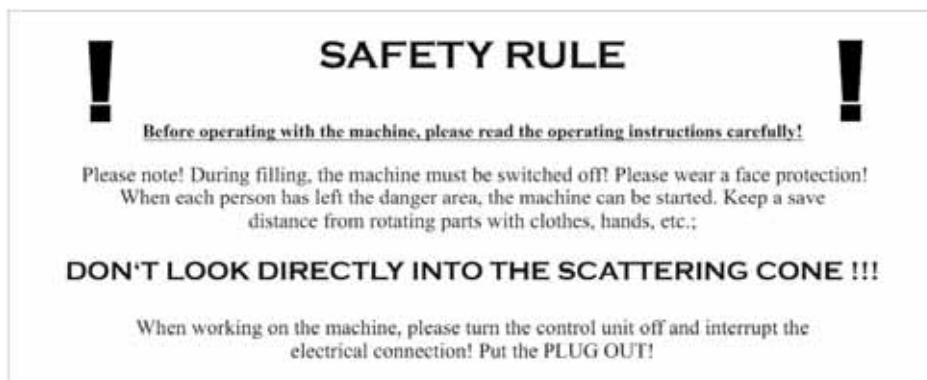

Sticker on hopper
Order-No.: 10559901

2. CE conformity mark:

The CE conformity placing through the producer documents outwards the conformity of the machine with all regulations of the directives of the machine and other corresponding EC directives

EC declaration of conformity (see attachement)

By signing the EC declaration of conformity the producer validates that the introduced machine complies with all constitutional safety and healthy requirements.

3. First steps:

Please check following points:

1. Check delivery for transport damages.
2. Check delivery for completeness according to delivery note.
3. Operating, commissioning and maintenance only according to the user manual.
4. Moving and rotating parts must be mounted tight.
5. Mount the machine correctly according to mounting guide and safety instructions.
6. Make a test run.
7. After all 40 hours of operation or at least before each operation the tightness of rotating parts must be checked.
8. Pay attention to the call signals (!). They are located everywhere to ensure your safety.
9. You will find all important safety instructions on the hopper and frame of the machine. If this sticker is lost it must be reordered! All safety information can be found in the Instruction point 1 and 5!
10. Please follow all relevant safety precautions as well as other general safety, health protection and road traffic instructions.

4. Dissemination:

The user has to be familiar with all safety and operating instructions of the machine. Therefore, it is necessary to hand the operating instruction on the user. The operating instruction will remain even after selling to the machine!

5. Safety instructions:

5.1. Danger area of machine

According to the working width the danger area changes. Take care of material that flies over the working width. F.e. Working width of 1,60 means that some corns can fly over 1,60m. Different weight of seeds leads to different working widths => danger area is the zone where flying material can injure or damage people, animals and objects.

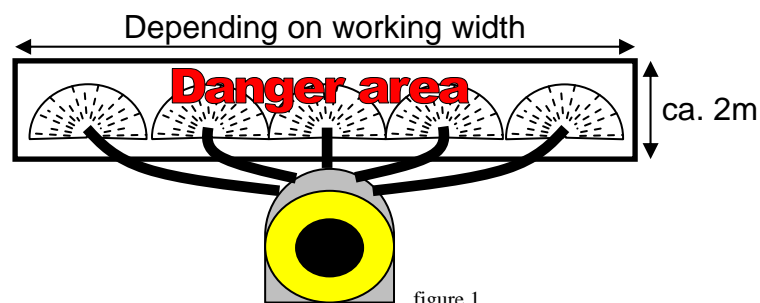

Other danger areas are agitator and seed roll, when the hopper cover is not closed. Don't look inside the hopper when the machine is switched on. Never look inside the spreader plates!

5.2. In general:

- ! Study the operating instruction exactly before start working!
- ! Keep enough safety distance during operation! All rotating and moving parts are very powerful and can pull in fingers or clothes! Take potential care when setting and calibrating the machine!
- ! Before start working make sure that no people, animals or things are in the danger area which can be damaged.
- ! When spreading agricultural chemicals please read the bag before purchasing the seed! Use safety clothing and breath mask when spread poisoned material!
- ! Empty the tank after completed work to avoid any risk to people and animals!
- ! Attention to the agitator! The emptying of the tank or replacement of the agitator bolt or other spare parts may execute with interrupted electrical connection!
- ! Keep children away of the machine!
- ! During operation: Do not open the lid of the tank and not look directly into the hopper and spreader plate!
- ! Make sure that the seeder is switched off (main control switch>OFF) and the feeder is closed before you connect the machine with battery!
- ! Do not enter the danger area during operation and during the machine is connected with electricity!
- ! **Before any work on the machine or its components take care that the power supply is interrupted!**
- ! Use safety clothing and breath mask when filling the tank!
- ! For each work with the machine you have to use your personal protection equipment (gloves, safety shoes with steel toe cap, ...)
- ! During calibration the danger area may only entered with switched off machine and interrupted electrical connection.
- ! Take care that no danger for people comes from the basic machine during remodelling of the seeder (=> switching off tractor (ignition), hydraulic assuring against moving, ...)

5.3. Control and electrical connection:

- ! To keep functionality of control unit keep it dry, protect it from shocks and falls, and also take care of correct polarity of battery (do not mix + and - !)
- ! Control unit box must be fixed beyond of danger area! (eg tractor cabin). Mount the cable not too tight. If the supplied cable is not sufficient, take care to the right cross section of the cable when extending this. Connections have to be clean, e.g. open wires are important to isolate and protruding wires are not allowed. For connection you can use suitable butt connectors.
- ! Make sure that the wires are correctly assembled at connections, so that enough electricity can flow through. Don't pinch the cable or led it over sharp edges!

- ! Protect cables against friction and heavy heat. When cable isolation is damaged please exchange immediately.
- ! Attention: Is the cable mounted too loose it can get stuck and pull out from the plug or break. Is the cable too long put it safe for persons and animals (e.g.: reeling and fitting safe in the cabine.)



5.4. Fitting and console:

Please note following points when mounting the seeder:

- ! If you mount an own fitting console, there must be a load capacity of the frame and the implement of at least [(weight of seeder + weight of hopper + max. filling weight) x2]!
- ! During operation seeder and frame are exposed strong vibrations. → Frame and bolting must stand these vibrations; check bolting after all 40 operating hours and before each operation to their fixed hub; also control cross beams and fitting console before and after each operation to damages and cracks! On the seeders is a square tube for fitting on the frame.
- ! The seeder must have enough space around it, so that settings and reconstruction work on the machine can be carried out safely!
- ! The steps for filling the hopper have to be according to DIN EN 14018. (Available with us)
- ! When mounting on the vehicle take care that the way out of the cabin is not blocked (= escape in emergency case).

6. Operation:

- For spreading rape, clover, mustard, slug corn, phacelia, lucerne, rye, oats, peas, micro granular, (wheat), grass seed, mineral fertilizer, phosphor, fertilizer, vetch ...
- For fitting on curry comb, disc harrow, grubber, roller, seedbed combine, grassland harrow, harvester, harvester thresher, ...
- ! The machine is developed for agricultural work to spread seeds, mirco granulate and fertilizer. For another operation warranty and product liability will expiate!

7. Warranty:

The manufacturer warranty is 1 year and applies in following points:

- Spare parts damaging because of original false fitting or material defect within this time.
- If you use original spare parts.

Warranty applies in following points:

- Spare parts, which have to be changed regularly on normal operation (abrasion).
- Spare parts damaging because of accidents, carelessness, misuses and faulty use and installation.
- If you use replica parts or spare parts from other manufacturers.
- If you not keep in mind operating and mounting instructions.

Before delivery each seeder will be checked out in all its functions during a long test run!

8. Product liability:

The product liability applies only to correct operation. If the seeder is not maintained correctly (eg regular control of scatter diagram and functionality of particular parts,...) the manufacturer assumes no liability.

9. Description:

See technical data sheet.

10. Mounting the machine

(Pay attention to special safety instruction 5.4.)

10.1. Mounting the hopper with machine frame:

The machine has a 50x50 square tube. For easy fitting just use a counter nut. Optional a 3-point frame or a bracket with counter plate is available from us:

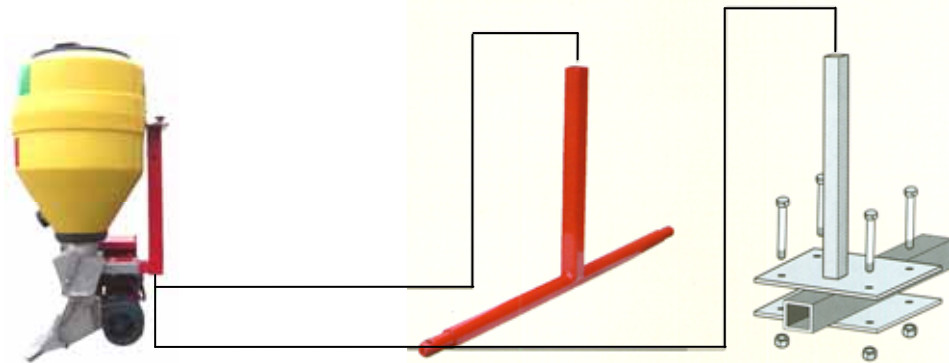

Order no.: 10619920

Order no.: 10619919



Vertical mounting - Perfect



Additional frame is necessary, to avoid pulling out of hopper. Depending on the angle some seed can stay inside the hopper. The working width gets smaller the bigger the angle is.

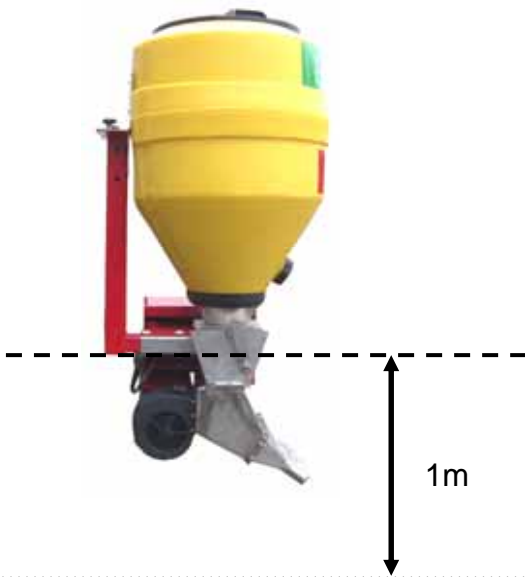

Recommended mounting height for small seed (f.e.: grass seed up to 3m working width) is 1m



Recommended mounting height for bigger seed (f.e.: fertilizer up to 3m working width) is 1,20m

When mounting the Öko-Air with the squar tube just fix the fixing screw when the seeder is in the correct position (height).

10.2. Notes for hose mounting:

Grass seed



Hose length max. 5m



Working width max. 6m
with spreader plates

Fertilizer



Hose length max. 2m



Working width max. 3m
with spreader plates
Inclination angle hose max. 65°

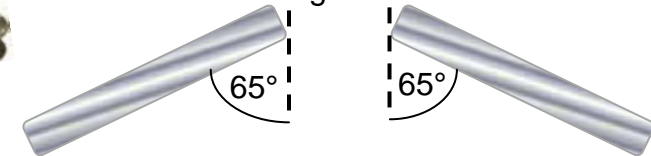

Oil radish



Hose length max. 2,5m



Working width max. 4,5m
with spreader plates
Inclination angle hose max. 75°



Micro granulate



Hose length max. 2,5m



Working width max. 4,5m
without spreader plates
Inclination angle hose max. 75°



10.3. Hints for hose mounting:

1. Keep the hoses at the beginning shorter and cut them at the end to the perfect length. Is the seeder mounted on a folded machine check before cutting the length of the hoses when the implement is folded and when it's not (Are the hoses too tight, will they get trapped, do they rub or get stuck somewhere, do they constrict some mechanism of the implement (e.g.: safety clip when folded))
2. The hoses must be mounted as tight as possible. Avoid sagging hoses (sagging hoses mean smaller working width). Keep the hoses as short as possible.
3. Spreader plates can be mounted vertical, horizontal or in any position inbetween. Depending on the mounting height one spreader plate can cover up to 100cm.

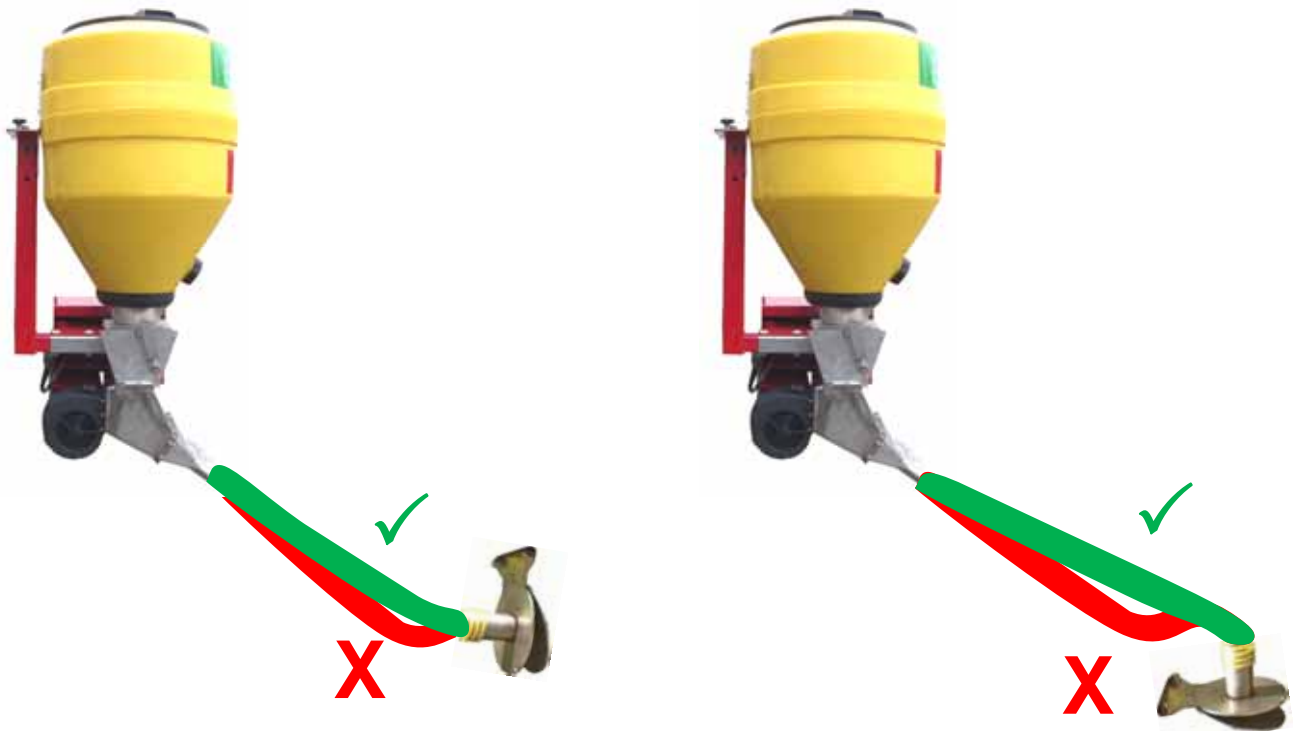
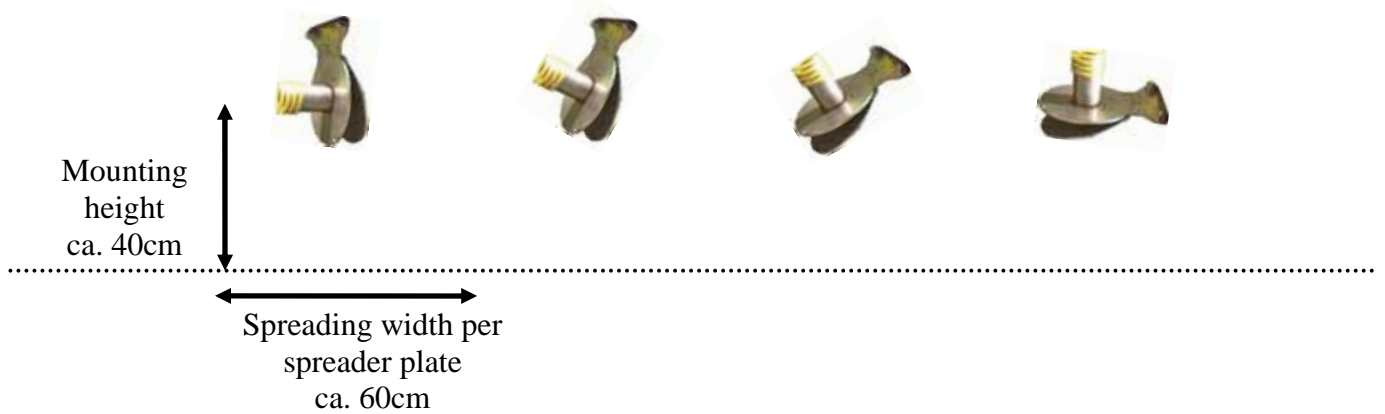

All information and recommendations for mounting are tested before. Because of different materials a higher mounting or a smaller inclination angle can be necessary.

10.4. Mounting of the ON/OFF sensor

The sensor stops the seed roll when no metal is opposite and switches the seed roll on when metal is opposite. Sensor-DM: 12mm; max. reacting distance: 2mm. Check if the sensor has contact. When the sensor has contact the led must shine. Be sure that the sensor switch off (Led doesn't shine)

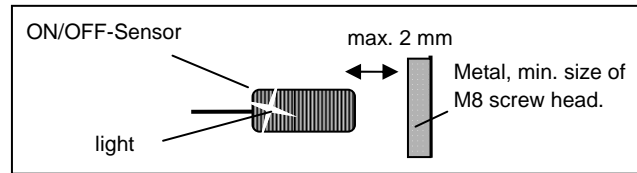

11. Control unit

(Pay attention to special safety instruction 5.3.)

11.1. Connection:

Connect the seeder direct to battery. Use the delivered battery cable with the battery clamps and fuse (**20A**) (**length 21cm**):

Take care of right connection with battery:

- + = Plus pole (red or no. 2) direct to battery (use the fuse)
- = Minus pole (black or no. 1) direct to battery

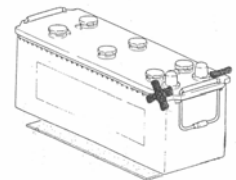

Attention: When mounting a plug (instead of delivered cable) be sure that enough power supply (same as direct from battery) exists. Otherwise the warranty expires!

11.2. Description:

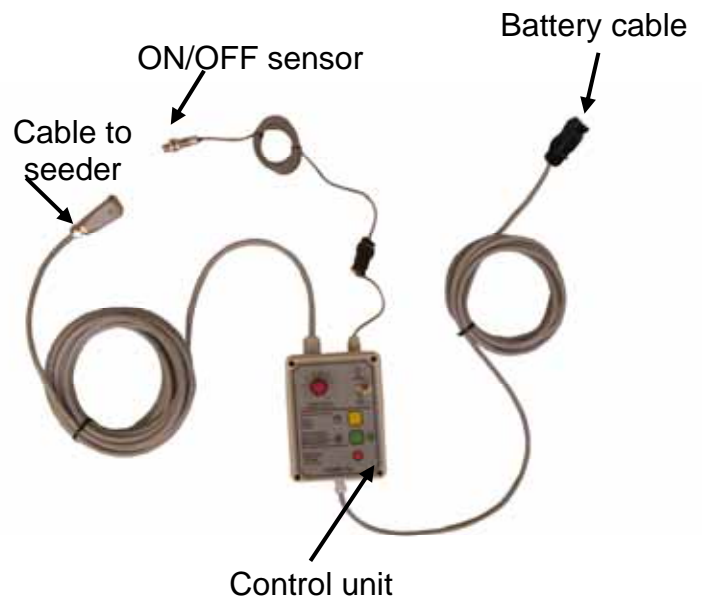
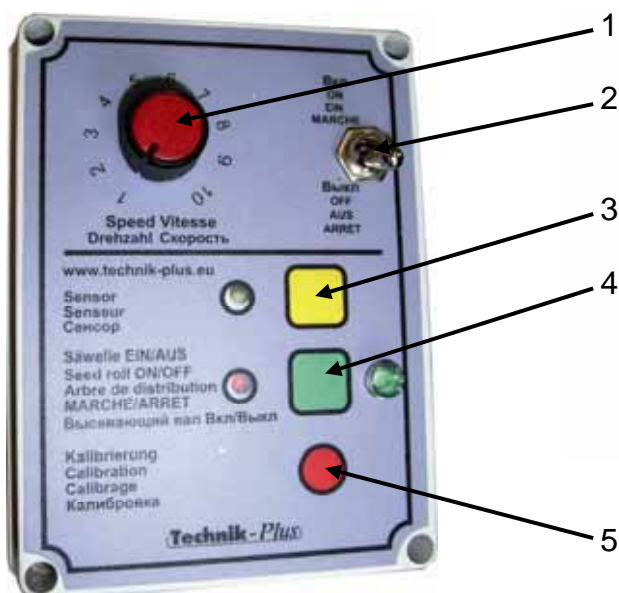

1. **Speed knob:** For adjusting the speed on the seed roll motor = adjusting of output amount. The amount can be changed during operation.

2. **Main switch:** This switch opens all functions on the unit.
WHEN WORKING ON THE MACHINE DISCONNECT POWER SUPPLY!

3. This button activates the **ON/OFF sensor**.
Yellow LED shines = sensor is active

Activation and Deactivation of ON/OFF sensor:

Switch off the unit with the main switch. Wait about 2 seconds. Switch on again and press immediately the yellow button for 2-3 seconds. When the yellow LED shines the sensor is active. Isn't it shining the sensor is not active.

4. For **switching ON/OFF the seed roll** and fan: When pressing this button the fan turns on first and after some seconds the seed roll starts turning. Press the button again for switching off. The seed roll stops and after some seconds the fan turns off. This avoids blocking in the hoses.

Red LED on left side shines = Seed roll and fan is turned on

Green LED on right side flashes = Seed roll turns

5. **Calibration function:** Only the seed roll turns on/off. Just for using during calibration. Don't use in general operation because the fan isn't working, the hoses will block.

6. Fuses in the unit

For fan: 15A

For seed roll motor: 10A

12. Operation

(Pay attention to special safety instruction 5. and 6.)

12.1. Preperation:

Is the correct seed roll mounted?

Mounting of seed roll see 13.1.

Is the flap correct adjusted?



When seeding small seed the seed roll should be in high position (as per picture). Otherwise it could happen that the output amount is more than adjusted. When using the standard seed roll or seed roll for small amount press the flap tight to the seed roll.

When using the metal seed roll be sure that there is a gap of about 2mm between seed roll and flap. The seed roll may not rub against the flap.

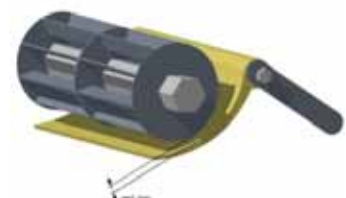

12.2. Calibration:

For calibration a bag which is permeable to air can be fitted on the outlets. Adjust the speed knob. Switch the seeder on for 1min and weigh the flown down seed (Subtract the weight of the bag or the collecting tray!). Compare this value with the calculated value. In the table beyond the weighed output amounts can be noted.

$$\frac{\text{Wished output amount kg/ha} \times \text{speed km/h} \times \text{working width m}}{600} = \text{weight kg/min}$$

$$\frac{5,0 \text{ kg/ha} \times 6 \text{ km/h} \times 1,2\text{m}}{600} = 0,06 \text{ kg/min}$$

Material:										
Adjusting speed knob										
	1	2	3	4	5	6	7	8	9	10
4										
5										
6										
7										
8										
9										
10										
11										
12										
13										
Material:										
Adjusting speed knob										
	1	2	3	4	5	6	7	8	9	10
4										
5										
6										
7										
8										
9										
10										
11										
12										
13										

Material:										
Adjusting speed knob										
	1	2	3	4	5	6	7	8	9	10
km/h	4									
	5									
	6									
	7									
	8									
	9									
	10									
	11									
	12									
	13									

Change the adjusting knob and do the calibration again until the calculated value and the weighed value are the same.

13. Additions

(Pay attention to special safety instruction 5. und 6.)

13.1. Changing of seed roll:

1. Disconnect the power supply by pulling the plug from battery!
2. Wear gloves and safety shoes with steel toe cap
3. Remove the lever from the flap. (Loos the nut)
4. Take off the cover on the side of the lever by removing the 6 screws..
5. Hold the hexagon shaft and change the seed roll.
6. Mount the cover with the 6 screws.
7. Mount the lever with the washer and the nut.

When mounting the seed roll be sure that on the left side a space of 0,3mm is left. The seed roll needs a little bit space for axial moves.

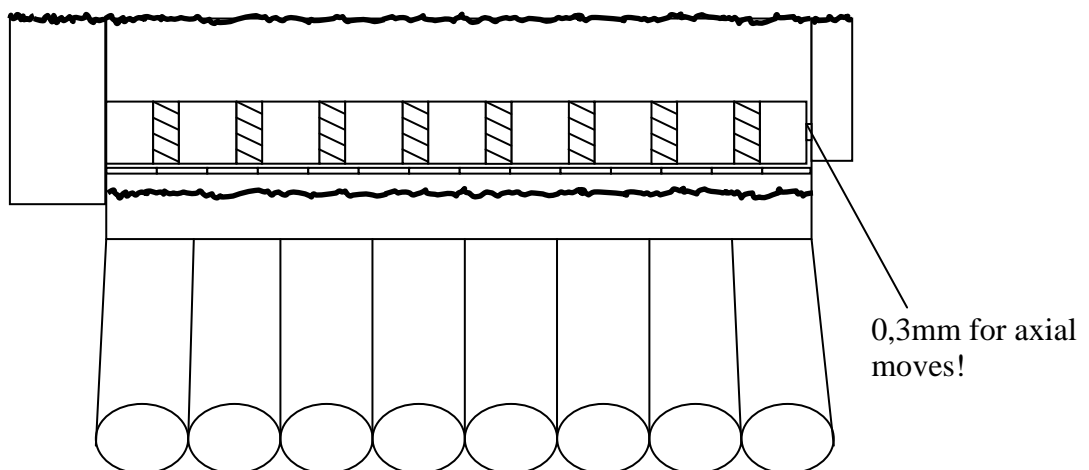

13.2. Connections:

Connection to battery:

From the control unit:

- + = Plus pole (red or no. 2) direct to battery (use the fuse)
- = Minus pole (black or no. 1) direct to battery

Short battery cable:

- + = Plus pole (red or no. 2) direct to battery (use the fuse)
- = Minus pole (black or no. 1) direct to battery

Socket and plug

(Connection seeder – control unit)

- Nr. 1: – Sensorsignal
- Nr. 2: + Seed roll motor
- Nr. 3: – Seed roll motor
- Nr. 4: + fan
- Nr. 5: – fan

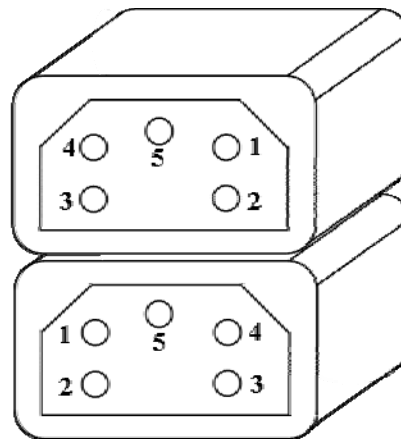

13.3. Service:

Before first operation and after 15min. check the Öko-Air (screws, connections, ...). Afterwards check this all 40 operation hours and before each operation. Clean the seeder occasionally.

The hopper is fixed with two hand screws for easy removing and cleaning. Most of the seed in the hopper can be removed by the rest emptying.

Clean the seeder with a damp cloth or with air compressor. Do not clean with pressure washer because motors can be damaged.

Store the seeder moisture proof. With good care and maintenance, the lifetime of the seeder increases.

ATTACHEMENT 1



Sämaschinen e.U.

Industrieparkstrasse 6-8
8480 Mureck, AUSTRIA
☎ 0043 (0) 3472 21120
☎ 0043 (0) 3472 21123
E-Mail: technik-plus@europart.at
<http://www.technik-plus.eu>
<http://www.europart.at>
UID-Nr.: ATU24080401
Firmenbuch: FN 328568 p

EG-KONFORMITÄTSERKLÄRUNG

im Sinne der EG-Richtlinie Maschinen 2006/42/EG, Anhang II A

Hiermit erklären wir, dass die Bauart von

ÖKO-AIR

In der gelieferten Ausführung folgenden einschlägigen Bestimmungen entspricht:
2006/42/EG

Technik-Plus

Sämaschinen e.U.

Industrieparkstrasse 6-8

A-8480 Mureck

www.technik-plus.eu

8480 Mureck, 27.09.2012

Ort und Datum der Ausstellung

Unterschrift (Firmenchef Josef Großauer)